

# C250

## KERB SIDES AND HARD SHOULDERS



SANITARY

SANITARY

GLUE

RAINGUTTERS

ROOFING  
ACCESSORIES

FASCIA AND  
ROOFING SOFFIT  
BOARDS

ACCES  
TRAP DOOR

VENTILATION

SURFACE DRAINAGE  
PRODUCTS

HYDRAULIC  
DRAINAGE CHANNELS

HYDRAULIC  
DRAINAGE CHANNELS

SAUL

ENVIRONMENT

All our documents can be downloaded free of charge from: [www.nicoll.fr](http://www.nicoll.fr)

# HYDRAULIC DRAINAGE CHANNELS - C250

## Connecto® - Width 130 ext.

	DESCRIPTION	DRAWINGS	REF.	Packing	Packaging
<b>POLYAMIDE GRATING</b>					
	<b>Channel length 1 m in PP with stainless steel edges and 2 polyamide gratings</b> Locked: 2 screw per grating		<b>CAN10CN</b>		Delivered per pallet of 32 m and sold per elements of 1 m
	<b>Pallet of 32 m</b> (Delivery unit)		<b>PAN10CN</b>		
	Set of screws to fix the gratings CAB10ATI (for 6 meters of channels) <i>To be ordered by set of 12 pieces</i>		<b>FIXCAN3</b>	S2	
	<b>End cap/end outlet</b>				
	Ø 100		<b>NAT177N</b>		10
	Ø 110		<b>NAV177N</b>		10
<b>DUCTILE IRON GRATING</b>					
	<b>PP channel 1 m with 2 ductile iron gratings, locked on channel body</b>		<b>CAL10CF</b>		Delivered per pallet of 56 m and sold per elements of 1 m
	<b>Pallet of 56 m</b> (Delivery unit)		<b>PAL10CF</b>		
	<b>End cap/end outlet</b>				
	Ø 100		<b>NAT178</b>		10
	Ø 110		<b>NAV178</b>		10
<b>ACCESSORIES</b>					
	<b>Vertical outlet Ø 100 - black</b>		<b>STDR10</b>		10
	<b>Vertical outlet Ø 110 - black</b>		<b>SVDR10</b>		10
	<b>Sump unit</b>				
	outlet Ø 100		<b>PSCVT</b>		5
	outlet Ø 110		<b>PSCVV</b>		5







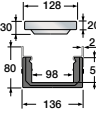

# Kenadrain® HD - Width 100 int.

	DESCRIPTION	DRAWINGS	REF.	Packing	Packaging
<b>POLYAMIDE GRATING</b>					
<b>PARK HD CHANNEL</b>					
<b>NEW GRATING !</b>	 <p><b>Channel length 1 m with galvanized steel edges and 2 polyamide gratings</b>  <b>Height 0 - 80 mm</b>                      Locking: 1 screw per grating on galvanized locking bar                      Stainless steel edges and locking device on request</p>		<b>DR100CN</b>		Delivered per pallet of 40 m and sold per elements of 1 m
	<b>Pallet of 40 m</b> (Delivery unit)		<b>PR100CN</b>		
<b>STEPPED-FALL HD CHANNEL</b>					
<b>NEW GRATING !</b>	 <p><b>Channel length 1 m with galvanized steel edges and 2 polyamide gratings</b>  <b>Height 1 - 130 mm</b>                      Locking: 1 screw per grating on galvanized locking bar                      Stainless steel edges and locking device on request</p>		<b>DR101CN</b>		Delivered per pallet of 40 m and sold per elements of 1 m
	<b>Pallet of 40 m</b> (Delivery unit)		<b>PR101CN</b>		
<b>NEW GRATING !</b>	<p>Standard height</p>  <p><b>Channel length 1 m with galvanized steel edges and 2 polyamide gratings</b>  <b>Height 2 - 170 mm</b>                      Locking: 1 screw per grating on galvanized locking bar                      Stainless steel edges and locking device on request</p>		<b>DR102CN</b>		Delivered per pallet of 40 m and sold per elements of 1 m
	<b>Pallet of 40 m</b> (Delivery unit)		<b>PR102CN</b>		
<b>NEW GRATING !</b>	 <p><b>Channel length 1 m with galvanized steel edges and 2 polyamide gratings</b>  <b>Height 3 - 210 mm</b>                      Locking: 1 screw per grating on galvanized locking bar                      Stainless steel edges and locking device on request</p>		<b>DR103CN</b>		Delivered per pallet of 35 m and sold per elements of 1 m
	<b>Pallet of 35 m</b> (Delivery unit)		<b>PR103CN</b>		
<b>NEW GRATING !</b>	 <p><b>Channel length 1 m with galvanized steel edges and 2 polyamide gratings</b>  <b>Height 4 - 250 mm</b>                      Locking: 1 screw per grating on galvanized locking bar                      Stainless steel edges and locking device on request</p>		<b>DR104CN</b>		Delivered per pallet of 28 m and sold per elements of 1 m
	<b>Pallet of 28 m</b> (Delivery unit)		<b>PR104CN</b>		

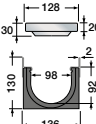
These channels could also be supplied with stainless steel edges.

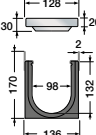

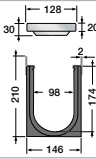

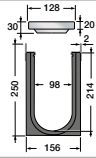

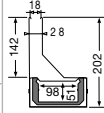

# HYDRAULIC DRAINAGE CHANNELS - C250

## Kenadrain® HD - Width 100 int.

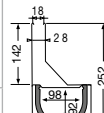
DESCRIPTION	DRAWINGS	REF.	Packing	Packaging
<b>GALVANIZED STEEL GRATING</b>				
<b>PARK HD CHANNEL</b>				
 <p><b>Channel length 1 m with galvanized steel edges and 1 galvanized steel mesh grating</b> <b>Height 0 - 80 mm</b> Locking: 2 screws per grating on galvanized locking bar</p>		<b>DR100CC</b>		Delivered per pallet of 40 m and sold per elements of 1 m
		<b>Pallet of 40 m</b> (Delivery unit)		
<b>STEPPED-FALL HD CHANNEL</b>				
 <p><b>Channel length 1 m with galvanized steel edges and 1 galvanized steel mesh grating</b> <b>Height 1 - 130 mm</b> Locking: 2 screws per grating on galvanized locking bar</p>		<b>DR101CC</b>		Delivered per pallet of 40 m and sold per elements of 1 m
		<b>Pallet of 40 m</b> (Delivery unit)		
<div style="background-color: red; color: white; padding: 2px; display: inline-block;">Standard height</div>  <p><b>Channel length 1 m with galvanized steel edges and 1 galvanized steel mesh grating</b> <b>Height 2 - 170 mm</b> Locking: 2 screws per grating on galvanized locking bar</p>		<b>DR102CC</b>		Delivered per pallet of 40 m and sold per elements of 1 m
		<b>Pallet of 40 m</b> (Delivery unit)		
 <p><b>Channel length 1 m with galvanized steel edges and 1 galvanized steel mesh grating</b> <b>Height 3 - 210 mm</b> Locking: 2 screws per grating on galvanized locking bar</p>		<b>DR103CC</b>		Delivered per pallet of 35 m and sold per elements of 1 m
		<b>Pallet of 35 m</b> (Delivery unit)		
 <p><b>Channel length 1 m with galvanized steel edges and 1 galvanized steel mesh grating</b> <b>Height 4 - 250 mm</b> Locking: 2 screws per grating on galvanized locking bar</p>		<b>DR104CC</b>		Delivered per pallet of 28 m and sold per elements of 1 m
		<b>Pallet of 28 m</b> (Delivery unit)		

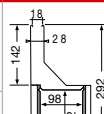

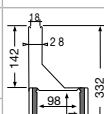

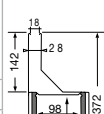

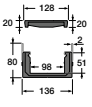

These channels could also be supplied with stainless steel edges.

# Kenadrain® HD - Width 100 int.

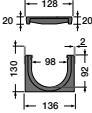
	DESCRIPTION	DRAWINGS	REF.	Packing	Packaging
<b>STAINLESS STEEL SLOT</b>					
<b>PARK HD CHANNEL</b>					
	<b>Channel length 1 m with 304 stainless steel side slot</b> (316 stainless steel on request)		<b>DRI100CSE</b>		
	<b>Channel length 1 m with stainless steel side slot and anti-leaves 304 stainless steel grating</b> (316 stainless steel on request)		<b>DRIG100CSE</b>		
	<b>50 cm inspection box with stainless steel slot</b>		<b>RDRI100CS</b>		
<b>STEPPED-FALL HD CHANNEL</b>					
	<b>Channel length 1 m with 304 stainless steel side slot</b> (316 stainless steel on request)		<b>DRI101CSE</b>		
	<b>Channel length 1 m with stainless steel side slot and anti-leaves 304 stainless steel grating</b> (316 stainless steel on request)		<b>DRIG101CSE</b>		
	<b>50 cm inspection box with stainless steel slot</b>		<b>RDRI101CS</b>		
<b>Standard height</b> 	<b>Channel length 1 m with 304 stainless steel side slot</b> (316 stainless steel on request)		<b>DRI102CSE</b>		
	<b>Channel length 1 m with stainless steel side slot and anti-leaves 304 stainless steel grating</b> (316 stainless steel on request)		<b>DRIG102CSE</b>		
	<b>50 cm inspection box with stainless steel slot</b>		<b>RDRI102CS</b>		
	<b>Channel length 1 m with 304 stainless steel side slot</b> (316 stainless steel on request)		<b>DRI103CSE</b>		
	<b>Channel length 1 m with stainless steel side slot and anti-leaves 304 stainless steel grating</b> (316 stainless steel on request)		<b>DRIG103CSE</b>		
	<b>50 cm inspection box with stainless steel slot</b>		<b>RDRI103CS</b>		
	<b>Channel length 1 m with 304 stainless steel side slot</b> (316 stainless steel on request)		<b>DRI104CSE</b>		
	<b>Channel length 1 m with stainless steel side slot and anti-leaves 304 stainless steel grating</b> (316 stainless steel on request)		<b>DRIG104CSE</b>		
	<b>50 cm inspection box with stainless steel slot</b>		<b>RDRI104CS</b>		
	Galvanized steel available on request				

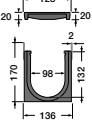
# HYDRAULIC DRAINAGE CHANNELS - C250

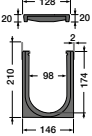

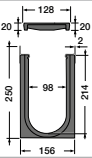



## Kenadrain® HD - Width 100 int.

	DESCRIPTION	DRAWINGS	REF.	Packing	Packaging
<b>HEEL DUCTILE IRON GRATING</b>					
<b>PARK HD CHANNEL</b>					
	<b>Channel length 1 m with galvanized steel edges and 2 ductile iron gratings - 6 mm slot width</b> <b>Height 0 - 80 mm</b> Locking: 1 screw per grating on galvanized locking bar		<b>DR100CH</b>		Delivered per pallet of 40 m and sold per elements of 1 m
	<b>Pallet of 40 m</b> (Delivery unit)		<b>PR100CH</b>		
<b>STEPPED-FALL HD CHANNEL</b>					
	<b>Channel length 1 m with galvanized steel edges and 2 ductile iron gratings - 6 mm slot width</b> <b>Height 1 - 130 mm</b> Locking: 1 screw per grating on galvanized locking bar		<b>DR101CH</b>		Delivered per pallet of 40 m and sold per elements of 1 m
	<b>Pallet of 40 m</b> (Delivery unit)		<b>PR101CH</b>		
	<b>Channel length 1 m with galvanized steel edges and 2 ductile iron gratings - 6 mm slot width</b> <b>Height 2 - 170 mm</b> Locking: 1 screw per grating on galvanized locking bar		<b>DR102CH</b>		Delivered per pallet of 40 m and sold per elements of 1 m
	<b>Pallet of 40 m</b> (Delivery unit)		<b>PR102CH</b>		
	<b>Channel length 1 m with galvanized steel edges and 2 ductile iron gratings - 6 mm slot width</b> <b>Height 3 - 210 mm</b> Locking: 1 screw per grating on galvanized locking bar		<b>DR103CH</b>		Delivered per pallet of 35 m and sold per elements of 1 m
	<b>Pallet of 35 m</b> (Delivery unit)		<b>PR103CH</b>		
	<b>Channel length 1 m with galvanized steel edges and 2 ductile iron gratings - 6 mm slot width</b> <b>Height 4 - 250 mm</b> Locking: 1 screw per grating on galvanized locking bar		<b>DR104CH</b>		Delivered per pallet of 28 m and sold per elements of 1 m
	<b>Pallet of 28 m</b> (Delivery unit)		<b>PR104CH</b>		

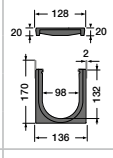
These channels could also be supplied with stainless steel edges.

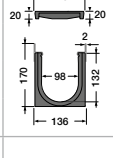
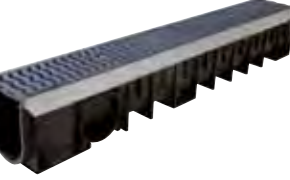
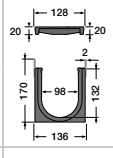

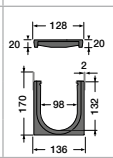
# Kenadrain® HD - Width 100 int.

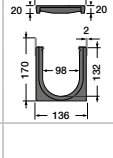
	DESCRIPTION	DRAWINGS	REF.	Packing	Packaging
<b>HEEL DUCTILE IRON GRATING IN VARIOUS COLOURS</b>					
<b>COLOUR GRATING</b>					
	<b>Channel length 1 m with galvanized steel edges and 2 ductile iron gratings - 6 mm slot width</b> Red Laterite - Nearest RAL codes 8015 Locking: 1 screw per grating on galvanized locking bar		<b>DR102CH8015</b>		Delivered per pallet of 40 m and sold per elements of 1 m
	<b>Pallet of 40 m</b> (Delivery unit)		<b>PR102CH8015</b>		
	<b>Channel length 1 m with galvanized steel edges and 2 ductile iron gratings - 6 mm slot width</b> Yellow Pyrite - Nearest RAL codes 1015 Locking: 1 screw per grating on galvanized locking bar		<b>DR102CH1015</b>		Delivered per pallet of 40 m and sold per elements of 1 m
	<b>Pallet of 40 m</b> (Delivery unit)		<b>PR102CH1015</b>		
	<b>Channel length 1 m with galvanized steel edges and 2 ductile iron gratings - 6 mm slot width</b> Blue Basalt - Nearest RAL codes 5008 Locking: 1 screw per grating on galvanized locking bar		<b>DR102CH5008</b>		Delivered per pallet of 40 m and sold per elements of 1 m
	<b>Pallet of 40 m</b> (Delivery unit)		<b>PR102CH5008</b>		
	<b>Channel length 1 m with galvanized steel edges and 2 ductile iron gratings - 6 mm slot width</b> Grey Lunare - Nearest RAL codes 7046 Locking: 1 screw per grating on galvanized locking bar		<b>DR102CH7046</b>		Delivered per pallet of 40 m and sold per elements of 1 m
	<b>Pallet of 40 m</b> (Delivery unit)		<b>PR102CH7046</b>		
	<b>Channel length 1 m with galvanized steel edges and 2 ductile iron gratings - 6 mm slot width</b> Green Malachite - Nearest RAL codes 6028 Locking: 1 screw per grating on galvanized locking bar		<b>DR102CH6028</b>		Delivered per pallet of 40 m and sold per elements of 1 m
	<b>Pallet of 40 m</b> (Delivery unit)		<b>PR102CH6028</b>		

These channels could also be supplied with stainless steel edges.









Channels with Heel grating of colour are also available for PARK and STEPPED-FALL Channels.

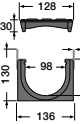

RAL 8015   RAL 1015   RAL 5008   RAL 7046   RAL 6028

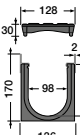
# HYDRAULIC DRAINAGE CHANNELS - C250

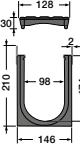
## Kenadrain® HD - Width 100 int.

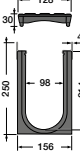
	DESCRIPTION	DRAWINGS	REF.	Packing	Packaging	
<b>DUCTILE IRON GRATING</b>						
<b>HD PARK CHANNEL</b>						
<b>NEW GRATING !</b>	 <p><b>Channel length 1 m with galvanized steel edges and 2 ductile iron gratings</b>  <b>Height 0 - 80 mm</b>                      Locking: 1 screw per grating on galvanized locking bar</p>		<b>DR100CF</b>		Delivered per pallet of 40 m and sold per elements of 1 m	
			<b>Pallet of 40 m</b> (Delivery unit)	<b>PR100CF</b>		
<b>STEPPED-FALL HD CHANNEL</b>						
<b>NEW GRATING !</b>	 <p><b>Channel length 1 m with galvanized steel edges and 2 ductile iron gratings</b>  <b>Height 1 - 130 mm</b>                      Locking: 1 screw per grating on galvanized locking bar</p>		<b>DR101CF</b>		Delivered per pallet of 40 m and sold per elements of 1 m	
			<b>Pallet of 40 m</b> (Delivery unit)	<b>PR101CF</b>		
<b>NEW GRATING !</b>	<div style="border: 1px solid red; padding: 2px; display: inline-block; color: white; font-weight: bold;">Standard height</div>  <p><b>Channel length 1 m with galvanized steel edges and 2 ductile iron gratings</b>  <b>Height 2 - 170 mm</b>                      Locking: 1 screw per grating on galvanized locking bar</p>		<b>DR102CF</b>		Delivered per pallet of 40 m and sold per elements of 1 m	
			<b>Pallet of 40 m</b> (Delivery unit)	<b>PR102CF</b>		
<b>NEW GRATING !</b>	 <p><b>Channel length 1 m with galvanized steel edges and 2 ductile iron gratings</b>  <b>Height 3 - 210 mm</b>                      Locking: 1 screw per grating on galvanized locking bar</p>		<b>DR103CF</b>		Delivered per pallet of 35 m and sold per elements of 1 m	
			<b>Pallet of 35 m</b> (Delivery unit)	<b>PR103CF</b>		
<b>NEW GRATING !</b>	 <p><b>Channel length 1 m with galvanized steel edges and 2 ductile iron gratings</b>  <b>Height 4 - 250 mm</b>                      Locking: 1 screw per grating on galvanized locking bar</p>		<b>DR104CF</b>		Delivered per pallet of 28 m and sold per elements of 1 m	
			<b>Pallet of 28 m</b> (Delivery unit)	<b>PR104CF</b>		

These channels could also be supplied with stainless steel edges.





# Kenadrain® HD - Width 100 int.

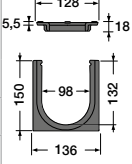

	DESCRIPTION	REF.	Packing	PACKAGING
<b>ACCESSORIES</b>				
   	<b>End cap/end outlet</b>			
	Height 0 - Ø 50	<b>NJDR100</b>		10
	Height 1 - Ø 75	<b>NPDR101</b>		10
	Height 2 - Ø 100	<b>NTDR102</b>		10
	Height 2 - Ø 110	<b>NVDR102</b>		10
	Height 3 - Ø 100	<b>NTDR103</b>		10
	Height 3 - Ø 110	<b>NVDR103</b>		10
	Height 4 - Ø 100	<b>NTDR104</b>		10
	Height 4 - Ø 110	<b>NVDR104</b>		10
	<b>Lateral/vertical outlet</b> (delivered with screws)			
	Lateral or vertical Ø 100	<b>STDR10</b>		10
	Lateral or vertical Ø 110	<b>SVDR10</b>		10
Lateral or vertical Ø 125	<b>SXDR10</b>		10	
Lateral or vertical Ø 160	<b>SZDR20</b>		10	
<b>Step connector</b>	<b>SAB10</b>			
<b>Adaptation part for Sump PS100X, PS100V, STDR10, SVDR10 and SXDR10 for depths 3 and 4 of stepped-fall range</b>	<b>ADPS100</b>			
<b>SECURITY LOCKING SYSTEM</b>				
	<b>Set of 24 security bolts</b>	<b>VISDRI</b>	S1	
	<b>Security lock key</b>	<b>CLEDRI</b>	S1	
<b>SAND BOX</b>				
	<b>50cm sand box, width 100 with galvanized steel edge with 1 ductile iron grating</b> - Sand boxes are available with all gratings of the range in width100.	<b>BS102CF</b>		8
<b>SUMP</b>				
	<b>Ekso sump with lower outlet</b>			
	width 100 - outlet Ø 125	<b>PS100X</b>		4
	width 100 - outlet Ø 110	<b>PS100V</b>		4
	<b>Ekso sump with upper outlet</b>			
width 100 - outlet Ø 125	<b>PS100XH</b>			
width 100 - outlet Ø 110	<b>PS100VH</b>			

# HYDRAULIC DRAINAGE CHANNELS - C250

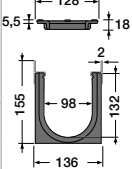
## Kenadrain® MD range - Width 100

		HEIGHT	REF.	Packing	Packaging
<b>CLASS C250</b>					
	<b>Channel length 1 m without galvanized steel edges and with 2 overlaying ductile iron gratings</b> Locking: 2 screws per grating		<b>DL102CF</b>		Delivered per pallet of 40 m and sold per elements of 1 m
	<b>Pallet of 40 m</b> (Delivery unit)		<b>PL102CF</b>		
	<b>Channel length 1 m with low galvanized steel edges and 2 ductile iron gratings</b> Locking: 1 screw per grating on galvanized locking bar		<b>DM102CF</b>		Delivered per pallet of 40 m and sold per elements of 1 m
	<b>Pallet of 40 m</b> (Delivery unit)		<b>PM102CF</b>		

## Kenadrain® MD accessories

		REF.	Packing	Packaging
<b>WIDTH 100</b>				
	<b>End cap/end outlet</b>			
	Ø 100	<b>NTDL102</b>		10
	Ø 110	<b>NVDL102</b>		10
	<b>Lateral/vertical outlet</b> (delivered with screws)			
	Lateral or vertical Ø 100	<b>STDR10</b>		10
	Lateral or vertical Ø 110	<b>SVDR10</b>		10
	Lateral or vertical Ø 125	<b>SXDR10</b>		10

# Kenadrain® HD - Width 150 int.

NEW GRATING !

	DESCRIPTION	DRAWINGS	REF.	Packing	Packaging
<b>DUCTILE IRON GRATING</b>					
	<b>Channel length 1 m with galvanized steel edges and 2 ductile iron gratings</b> Locking: 4 screws per grating		<b>DR152CF</b>		Delivered per pallet of 30 m and sold per elements of 1 m
	<b>Pallet of 30 m</b> (Delivery unit)		<b>PR152CF</b>		
<b>STAINLESS STEEL SLOT</b>					
 	<b>Channel length 1 m with 304 stainless steel side slot</b> (316 stainless steel on request)		<b>DRI152CSE</b>		
	<b>Channel Length 1 m with 304 stainless steel anti-leaves grating</b> (316 stainless steel on request)		<b>DRIG152CSE</b>		
	<b>50 cm Inspection box stainless steel with slot</b> (316 stainless steel on request)		<b>RDRI152CS</b>		
<b>ACCESSORIES</b>					
 	<b>End cap/end outlet</b> Ø 125		<b>NXDR152</b>		10
	<b>Lateral/vertical outlet</b> (delivered with screws) Lateral Ø 125		<b>SXDR10</b>		10
	Vertical Ø 160		<b>SZDR20</b>		10
<b>SECURITY LOCKING SYSTEM</b>					
 	<b>Set of 24 security bolts</b>		<b>VISDRI</b>	S1	
	<b>Security lock key</b>		<b>CLEDRI</b>	S1	
<b>SUMP</b>					
 	<b>Ekso sump with lower outlet</b> width 150 - outlet Ø 160		<b>PS150Z</b>		2
	<b>Ekso sump with upper outlet</b> width 150 - outlet Ø 160		<b>PS150ZH</b>		

# HYDRAULIC DRAINAGE CHANNELS - C250

## Kenadrain® HD - Width 200 int.

	DESCRIPTION	DRAWINGS	REF.	Packing	Packaging
<b>DUCTILE IRON GRATING</b>					
<b>NEW GRATING !</b>	 <p><b>Channel length 1 m with galvanized steel edges and 2 ductile iron gratings</b> Locking: 4 screws per grating</p>		<b>DR202CF</b>		Delivered per pallet of 20 m and sold per elements of 1 m
	<b>Pallet of 20 m</b> (Delivery unit)		<b>PR202CF</b>		
<b>ACCESSORIES</b>					
	<b>End cap/end outlet</b> Ø 160		<b>NZDR202</b>		10
	<b>Lateral/vertical outlet</b> (delivered with screws)				
	Lateral Ø 160		<b>SZDR20</b>		10
	Vertical Ø 200		<b>SBDR20</b>		10
<b>SECURITY LOCKING SYSTEM</b>					
	<b>Set of 24 security bolts</b>		<b>VISDRI</b>	S1	
	<b>Security lock key</b>		<b>CLEDRI</b>	S1	
<b>SUMP</b>					
	<b>Ekso sump with lower outlet</b> width 200 - outlet Ø 200		<b>PS200B</b>		2
	<b>Ekso sump with upper outlet</b> width 200 - outlet Ø 200		<b>PS200BH</b>		

# Kenadrain® HD - Width 300 int.

NEW GRATING !



DESCRIPTION	DRAWINGS	REF.	Packing	Packaging
<b>DUCTILE IRON GRATING</b>				
<b>Channel length 1 m with galvanized steel edges and 2 ductile iron gratings</b> Locking: 4 screws per grating		<b>DR302CF</b>		Delivered per pallet of 9 m and sold per elements of 1 m
<b>Pallet of 9 m (Delivery unit)</b>		<b>PR302CF</b>		

## ACCESSORIES



<b>End cap/end outlet</b> Ø 250		<b>NDDR302</b>		
<b>Lateral/vertical outlet (delivered with screws)</b> Lateral Ø 200		<b>SBDR20</b>		10
Vertical Ø 315		<b>SEDR30</b>		10

## SECURITY LOCKING SYSTEM



<b>Set of 24 security bolts</b>		<b>VISDRI</b>	S1	
<b>Security lock key</b>		<b>CLEDRI</b>	S1	

## SUMP



<b>Ekso sump with lower outlet</b> width 300 - outlet Ø 315		<b>PS300E</b>		
<b>Sump Ekso with upper outlet</b> width 300 - outlet Ø 315		<b>PS300EH</b>		